

AC 18 AWG Super-Trex® SJOO Micro Quick-Connect™ Receptacles

- RoHS Compliant
- IP67 Rated

AC 18 AWG Female receptacles are available as back mount or panel mount. Male receptacles are available as panel mount or switch body mount. O-ring and locknut included; AC Micro closure caps with chain are sold separately.

APPLICATIONS

- Bar Code Readers
- Computer Interfaces
- Digital Remote Controls
- Encoders or Resolvers
- Heat Pressure and Flow Meters
- Instrumentation
- I/O (input/output) Devices
- Load Cell Monitors
- Programmable Controllers
- Programmable Limit Switches
- Proximity Switches
- Robotics
- Servo Motors
- Sensors and Relays
- Solenoid Valves
- Tachometers
- Telecommunications
- Torque-Tool Monitoring Equipment
- X-Ray Monitors
- Variable Speed Motors

ORDERING INFORMATION (MINIMUM PURCHASE MAY BE REQUIRED IF PRODUCT NOT STOCKED)

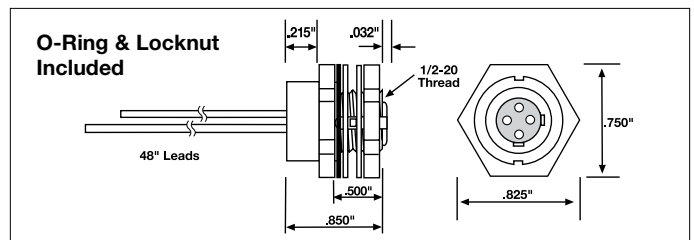
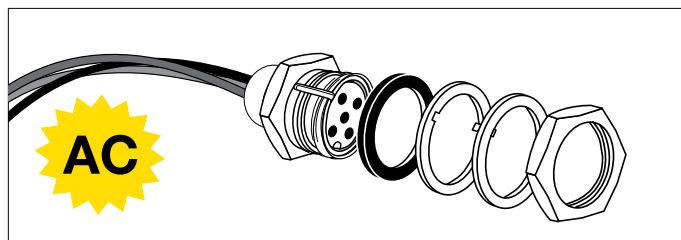

FEMALE RECEPTACLE – BACK MOUNT

PART NO.	PART NO.	DESCRIPTION	PIGTAIL LENGTH
67308	RG13Q28F004	3P Female Back Mount	48"
67408	RG14Q29F004	4P Female Back Mount	48"
67508	RG15Q30F004	5P Female Back Mount	48"

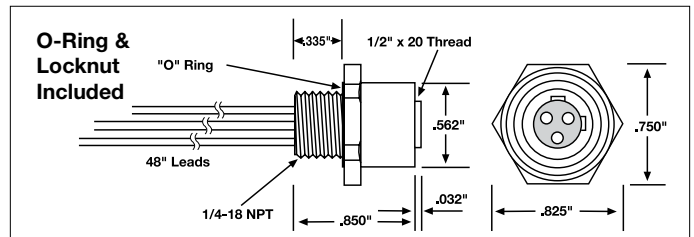
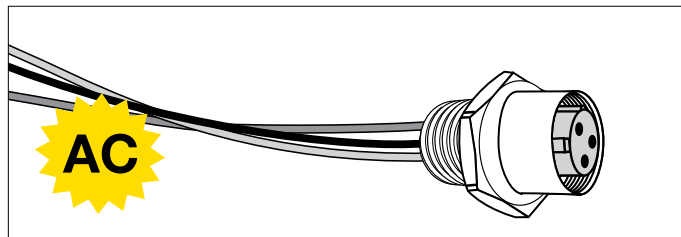

FEMALE RECEPTACLE – PANEL MOUNT

PART NO.	PART NO.	DESCRIPTION	PIGTAIL LENGTH
67302	RG13T28F004	3P Female Panel Mount	48"
67402	RG14T29F004	4P Female Panel Mount	48"
67502	RG15T30F004	5P Female Panel Mount	48"

AC MICRO CLOSURE CAPS WITH CHAIN

PART NO.	DESCRIPTION
64901	Closure Cap with 6" Chain for Male Plug & Receptacles with External Thread
64901S	Stainless Steel Closure Cap for Male Plug & Receptacle
64902	Closure Cap with 6" Chain for Female Plug & Receptacles with Internal Thread
64902S	Stainless Steel Closure Cap for Female Plug & Receptacle

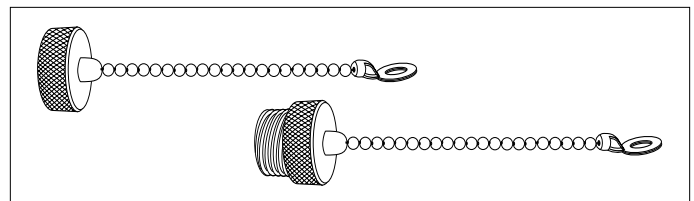

AC 18 AWG Super-Trex® SJ00 Micro Quick-Connect™ Receptacles (Continued)

ORDERING INFORMATION (MINIMUM PURCHASE MAY BE REQUIRED IF PRODUCT NOT STOCKED)

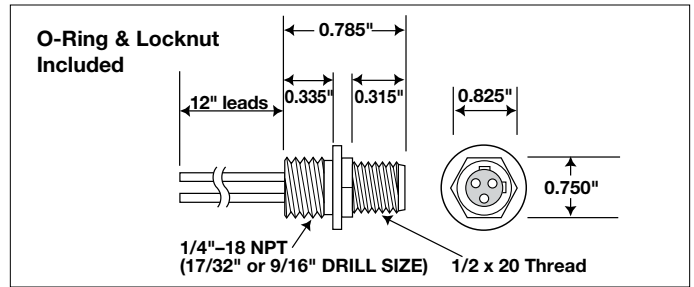
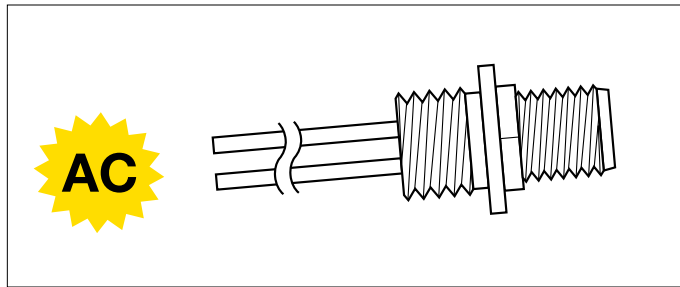

MALE RECEPTACLE – PANEL MOUNT			
PART NO.	PART NO.	DESCRIPTION	PIGTAIL LENGTH
65302	RG13R28F001	3P Male Panel Mount	12"
65402	RG14R29F001	4P Male Panel Mount	12"
65502	RG15R30F001	5P Male Panel Mount	12"
—	RG13R28F004	3P Male Panel Mount	48"
—	RG14R29F004	4P Male Panel Mount	48"
—	RG15R30F004	5P Male Panel Mount	48"

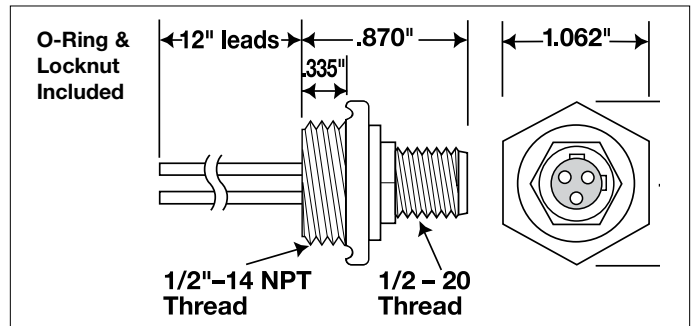
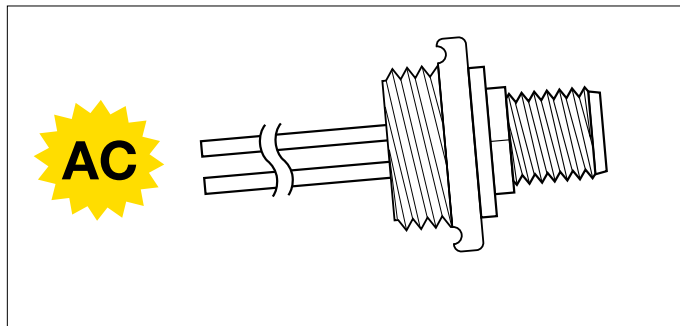

MALE RECEPTACLE – SWITCH BODY MOUNT			
PART NO.	PART NO.	DESCRIPTION	PIGTAIL LENGTH
65307	RG13S28F001	3P Male Switch Body	12"
65407	RG14S29F001	4P Male Switch Body	12"
65507	RG15S30F001	5P Male Switch Body	12"
—	RG13S28F004	3P Male Switch Body	48"
—	RG14S29F004	4P Male Switch Body	48"
—	RG15S30F004	5P Male Switch Body	48"

FACE VIEW OF FEMALE PLUGS

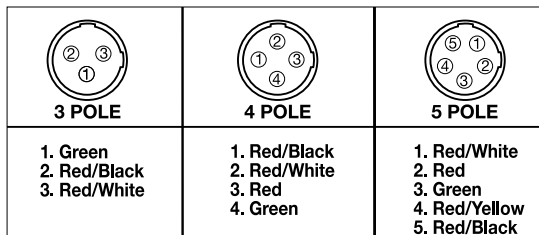

Mini Quick-Connects™
 Micro Quick-Connects™
 Nano Quick-Connects™
 Specialty Quick-Connects™
 Ethernet Cable Assemblies
 7 Pin Molded Valve Plug
 DIN Connectors
 Extension Cords
 M23 Connector Assemblies
 Military Connectors
 Rectangular Connectors